

Simpósio Latino Americano de Polimorfismo e Cristalização em Fármacos e Medicamentos

30 de setembro a 2 de outubro de 2007 - Fortaleza (CE)

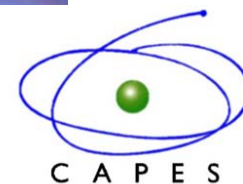

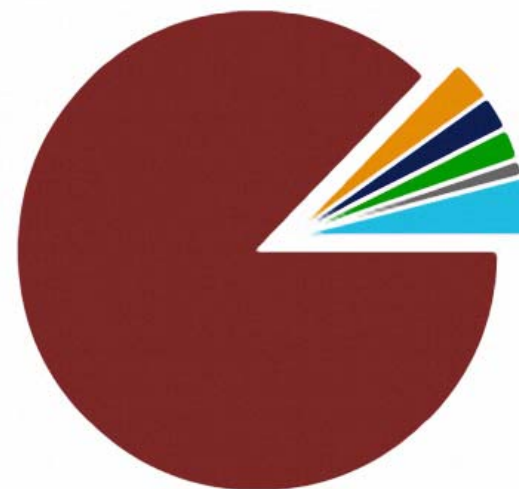

	BRAZIL : 2.803
	URUGUAY : 93
	UNITED STATES : 79
	ARGENTINA : 70
	VENEZUELA : 38
	other : 130
	BRAZIL : 87.2 %



**Simpósio Latino Americano de Polimorfismo e Cristalização
em Fármacos e Medicamentos**

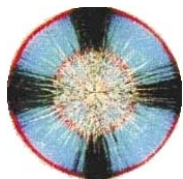

Simpósio Latino Americano de Polimorfismo e Cristalização em Fármacos e Medicamentos



**Simpósio Latino Americano de Polimorfismo e Cristalização
em Fármacos e Medicamentos**

Based on Charles Minard's graph of Napoleon's Russian campaign of 1812.

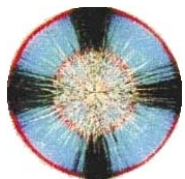
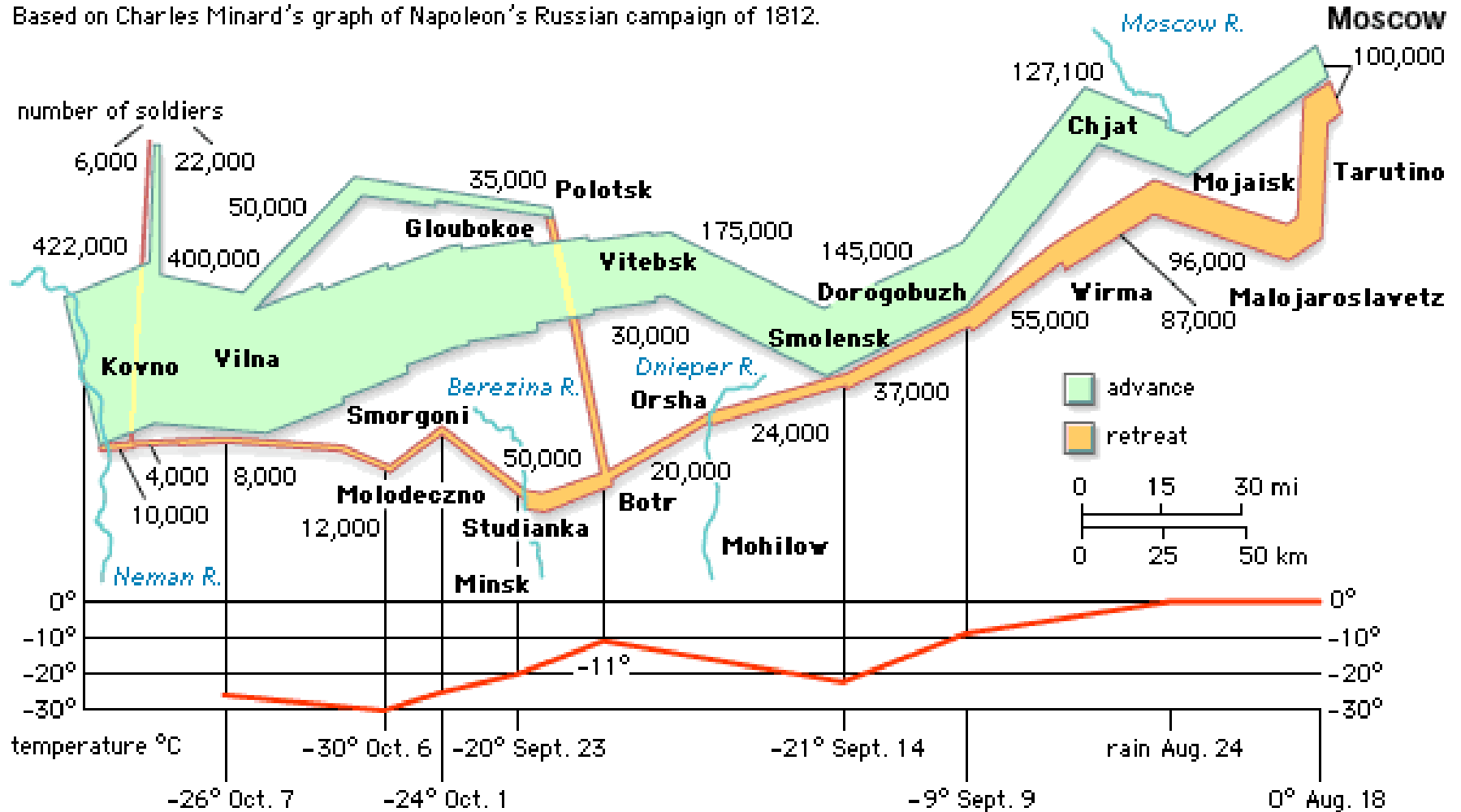

Simpósio Latino Americano de Polimorfismo e Cristalização em Fármacos e Medicamentos



Tin pest

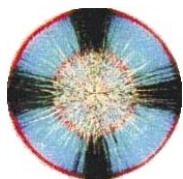
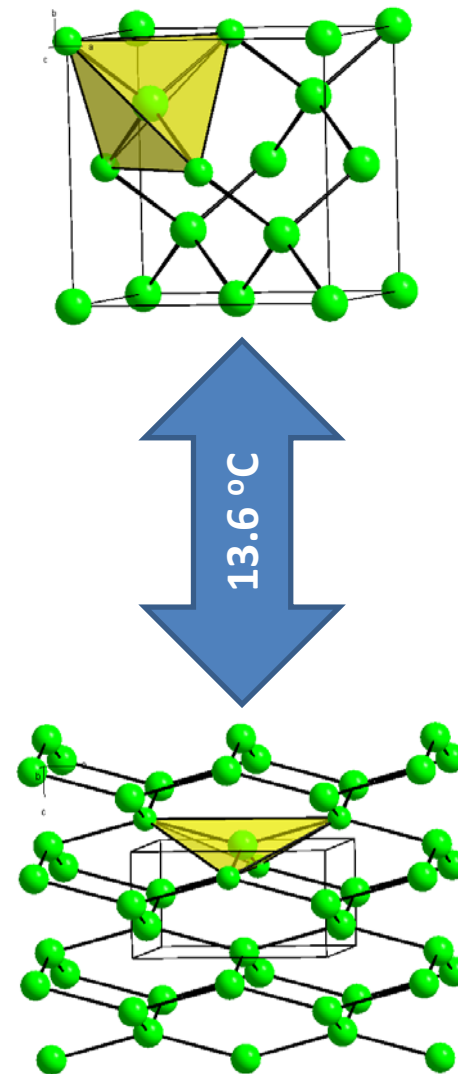

Simpósio Latino Americano de Polimorfismo e Cristalização
em Fármacos e Medicamentos



Grafite



Diamante

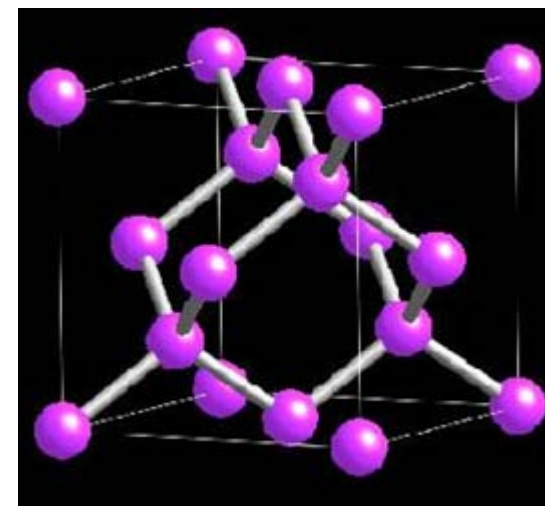
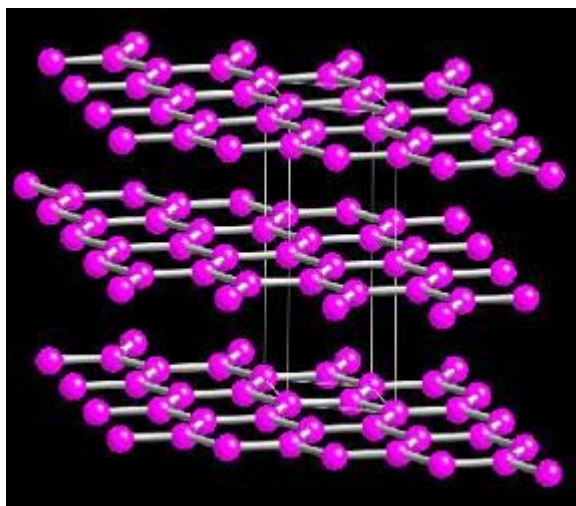

**Simpósio Latino Americano de Polimorfismo e Cristalização
em Fármacos e Medicamentos**



Safety and efficacy



Higher profits

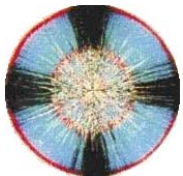

Simpósio Latino Americano de Polimorfismo e Cristalização em Fármacos e Medicamentos

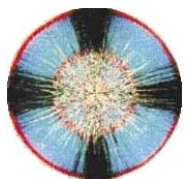
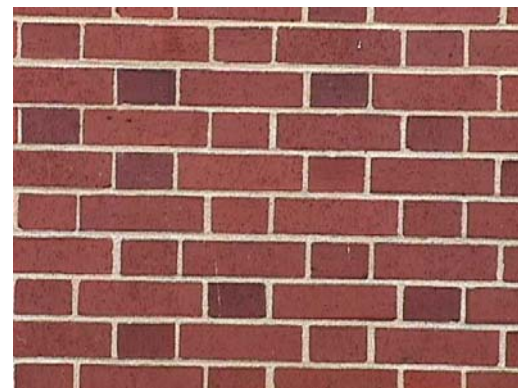
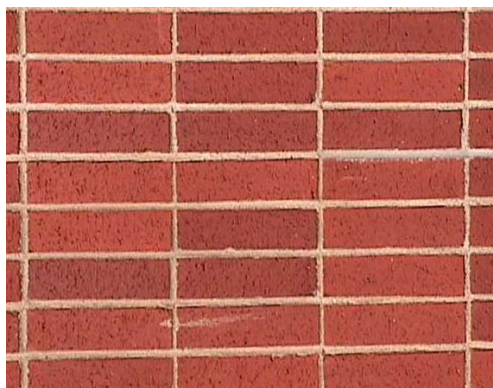
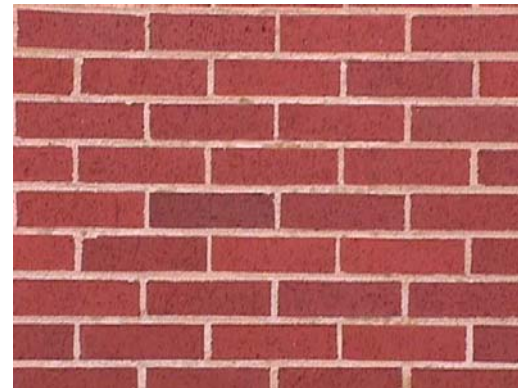
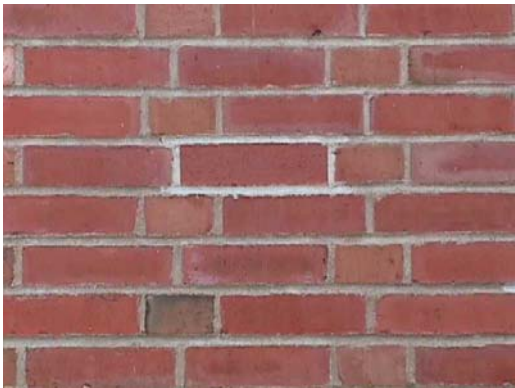

**Simpósio Latino Americano de Polimorfismo e Cristalização
em Fármacos e Medicamentos**

01/10 – 08:30 hs

Importance and incidence of crystal forms among drug substances

Ulrich Griesser

Institute of Pharmacy, University of Innsbruck, Austria

01/10 – 09:30 hs

Cocrystals, Salts, Solvates and Polymorphs: Scientific achievement or nuisance for pharmacy?

Roland Boese

Structural Chemistry Group, University of Duisburg-Essen, Germany

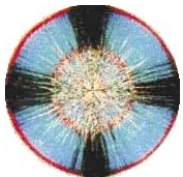

**Simpósio Latino Americano de Polimorfismo e Cristalização
em Fármacos e Medicamentos**

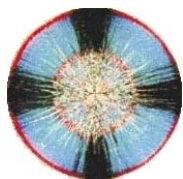

**Simpósio Latino Americano de Polimorfismo e Cristalização
em Fármacos e Medicamentos**

01/10 – 10:50 hs

Vibrational Spectroscopy (Raman, Mid-infrared, Near-infrared): Powerful Tools for Research, Quality Control and Process Monitoring in the Pharmaceutical Industry

Heinz W. Siesler

Department of Physical Chemistry, University of Duisburg-Essen, Germany

01/10 – 11:50 hs

Propriedades de estado sólido de princípios ativos farmacêuticos

Javier Ellena

Instituto de Física de São Carlos, Universidade de São Paulo



**Simpósio Latino Americano de Polimorfismo e Cristalização
em Fármacos e Medicamentos**

01/10 – 10:50 hs

Propriedades físicas e mecânicas de sólidos que afetam a qualidade de medicamentos

Marcio Labastie

Instituto Nacional de Controle de Qualidade em Saúde, Fundação Oswaldo Cruz

01/10 – 11:50 hs

Impacto do polimorfismo na bioequivalência e biodisponibilidade dos medicamentos

Silvia Storpirtis

Faculdade de Ciências Farmacêuticas da Universidade de São Paulo

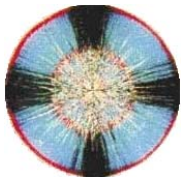

**Simposio Latino Americano de Polimorfismo e Cristalização
em Fármacos e Medicamentos**

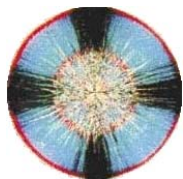

Simpósio Latino Americano de Polimorfismo e Cristalização
em Fármacos e Medicamentos

01/10 – 10:50 hs

Murilo Freitas Dias
Gerência de Farmacovigilância, ANVISA

01/10 – 11:50 hs

Manoel Odorico de Moraes
Unidade de Farmacologia Clínica, Departamento de Fisiologia e
Farmacologia, Universidade Federal do Ceará



**Simposio Latino Americano de Polimorfismo e Cristalização
em Fármacos e Medicamentos**

Innovative

or

Obvious

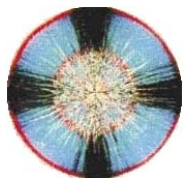
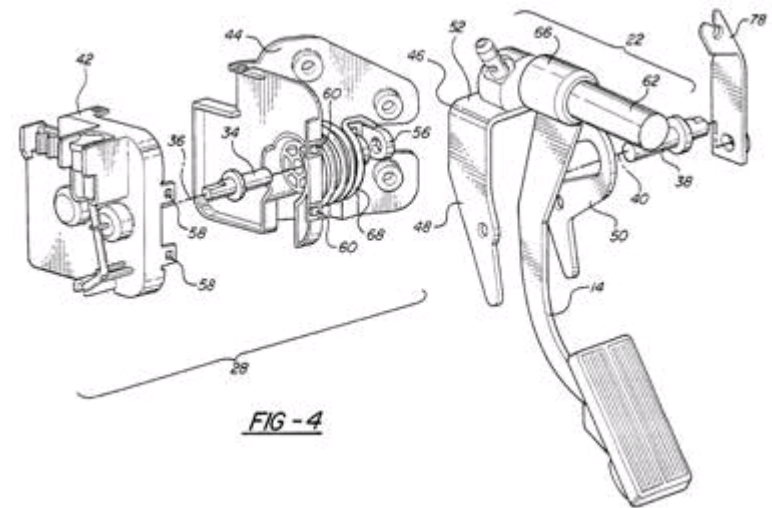
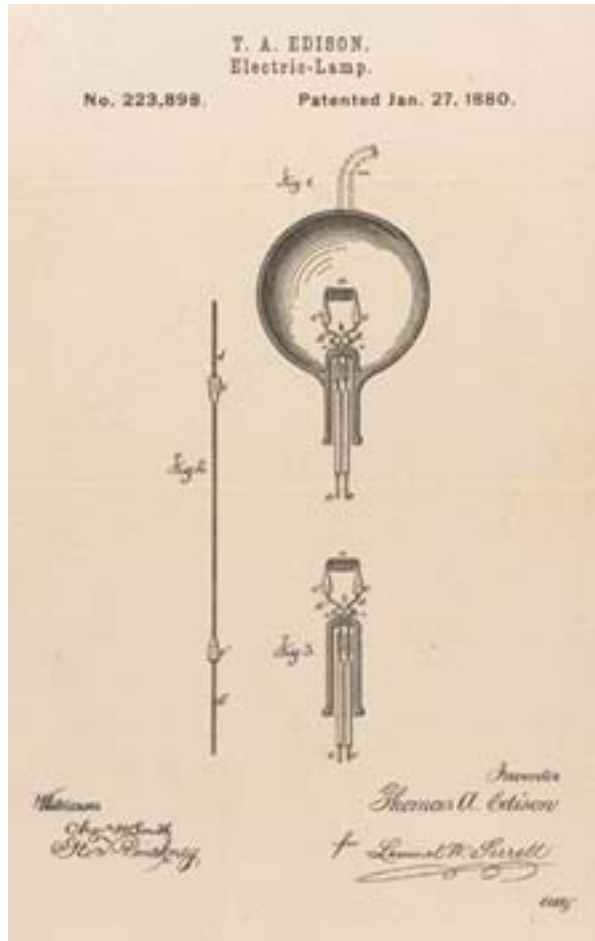

Simpósio Latino Americano de Polimorfismo e Cristalização em Fármacos e Medicamentos

02/10 – 08:30 hs

Polimorfos: patentear ou não?

Liane Lage

Chefe da Divisão de Patentes Química Orgânica, Fármacos e Correlatos, INPI

02/10 – 11:50 hs

Patenteamento de polimorfos: algumas questões relevantes

Altivo Pitaluga Jr

Fundação Oswaldo Cruz

02/10 – 15:45 hs

Patentes: abusos e oportunidades

Sandra Leite

Gerente de Informações e Patentes, Libbs Farmacêutica Ltda



**Simpósio Latino Americano de Polimorfismo e Cristalização
em Fármacos e Medicamentos**

02/10 –17:00 hs

Mesa redonda

Polimorfismo na indústria farmacêutica: propriedade intelectual e legislação

Liane Lage (INPI)

Sergio de Andrade Nishioka (ANVISA)

Altivo Pitaluga (FIOCRUZ)

Sandra Leite (LIBBS LTDA.)



Simpósio Latino Americano de Polimorfismo e Cristalização em Fármacos e Medicamentos

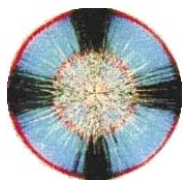

**Simpósio Latino Americano de Polimorfismo e Cristalização
em Fármacos e Medicamentos**